

Congratulations on taking this important step toward living a healthier life.

By keeping track of your radon and indoor air quality levels, you can make healthier decisions in the spaces where you spend most of your time. Reducing your exposure to radon will reduce your risk of lung cancer.

The Airthings House Kit contains everything you need to start monitoring the quality of your air, for a healthier home. The Hub brings your Airthings devices online, providing on-demand access to your indoor air quality data at any time, from anywhere. Connect to the Airthings Wave App to get started.

Breathe better, live better,

The Airthings Team

Get in touch



For technical support or if you have any questions or comments that we did not answer here, you can reach us the following ways:

- The Support menu in the Airthings Wave mobile app
- Chat bubble on the airthings.com website
- Send an email to support@airthings.com

What's in the box

Airthings Hub

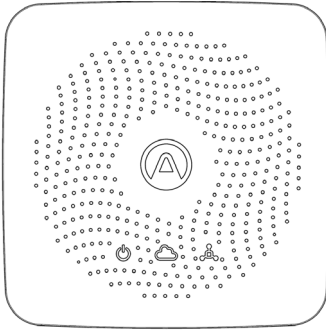

Power supply and plugs

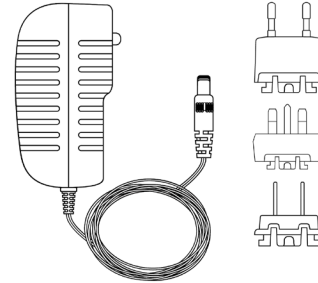

Ethernet cable

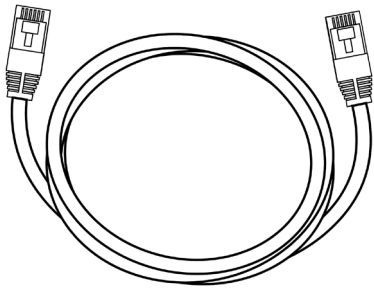

Rubber bumper pads

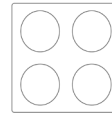

Wave, screw

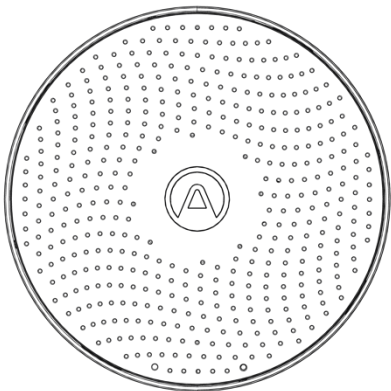

Wave Mini, stand

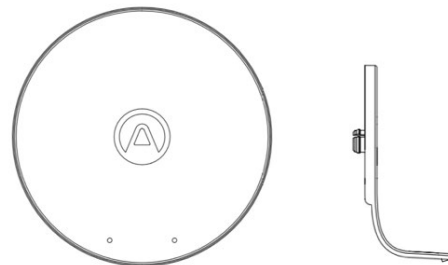

Device Specifications

Hub Specifications

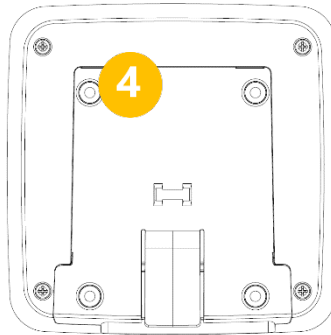
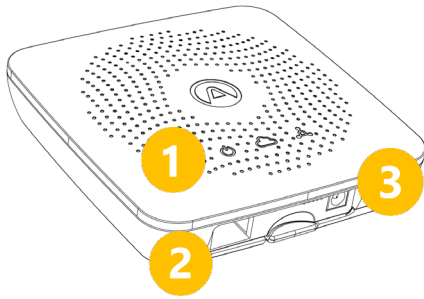

Connectivity

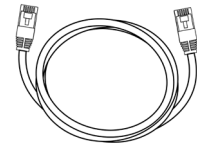

Ethernet

1. Light indicators
2. Ethernet port

3. Power input
4. Wall mounting bracket

Light Indicators



Power supply is connected and Hub is running



Communication with Airthings cloud is successful



One or more Wave devices are connected and actively sending data

Communication



Bluetooth low energy
(for adding Hub only)



Airthings Smartlink
868 / 915 Mhz

Power Supply



Input:
100-240VAC / 50-60Hz

Output:
5VDC / 2A

Dimensions & Weight



125 x 125 x 25 mm
(4.9 x 4.9 x 1")



249g (8.8oz)

Wave Specifications

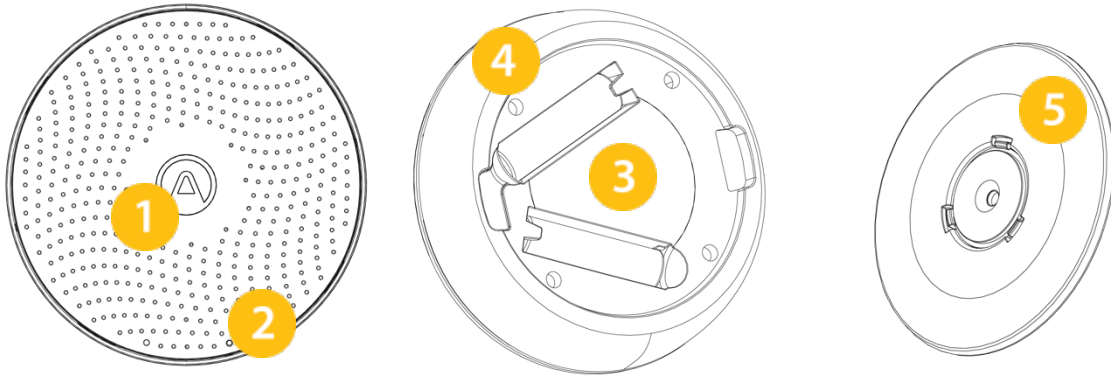

1. Glow ring
2. Wave sensor
3. Battery compartments (2 AA batteries inserted)
4. Individual serial number
5. Magnetic mounting bracket

Communication



Bluetooth low energy



Airthings Smartlink
868 / 915 Mhz

Dimensions & Weight



153 x 153 x 46 mm
(6 x 6 x 1.8")





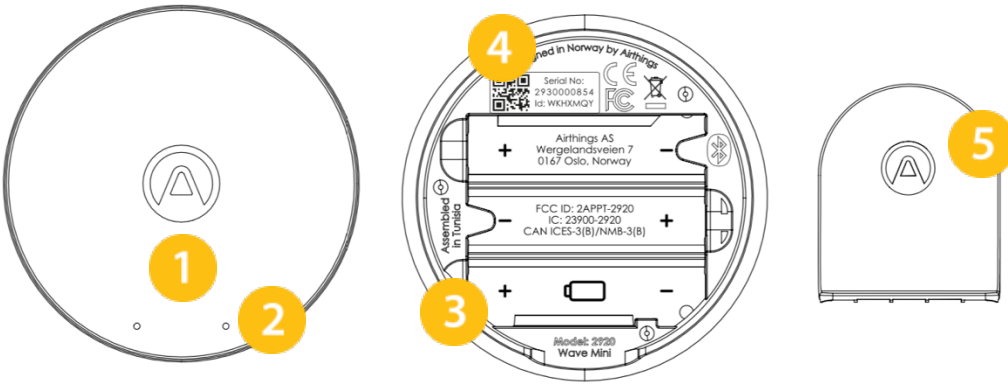

346g (12.2oz)

Wave Mini Specifications



- 1. Glow signal
- 2. Wave sensor
- 3. Battery compartments (3 AA batteries inserted)
- 4. Individual serial number
- 5. Device stand

Communication	Dimensions & Weight
 Bluetooth low energy	 80 x 80 x 26 mm (3.1 x 3.1 x 1")
 Airthings Smartlink 868 / 915 Mhz	 135g (4.8oz)

House Kit Setup

STEP 1 Airthings Wave App

Download or update the *Airthings Wave* App from the Apple App Store or Google Play Store and create an account. If you already have *Airthings Wave* App and Airthings Wave devices, please sync sensor data before proceeding.

STEP 2 Assembly

Assemble the power supply adapter for the Airthings Hub using your regional power plug.

STEP 3 Placement

Place the Hub near a free Ethernet port. It should be placed at least 30cm / 1ft away from WiFi routers and other WiFi enabled devices. The range of the Hub should be long enough to cover even a large family home.

The Hub should be placed in normal indoor environmental conditions and can be either placed wall mounted or lying down on a flat surface.

STEP 4 Connections

Connect the Ethernet cable and power supply. You should see the Hub power indicator light up.

After 10 seconds, the Hub cloud indicator should light up to indicate successful communication between the Hub and the Airthings cloud.

STEP 5 Add Hub to your Airthings account

Add your Hub to your account using the  sign in the App.

This step requires Bluetooth to be enabled on your phone to find the Hub. Android also requires location to be enabled.

The phone should be less than 1m / 3ft away from the Hub when the Airthings Wave app searches for the Hub.

Note:



When adding the Hub, it is very important that the correct region is selected (Europe / North America) for proper functionality. This ensures that the correct wireless frequency is used by the Hub for your region.

Note:

Adding a Hub or Wave device must be done through the Airthings Wave App and not through the Bluetooth settings of the phone.

STEP 6

Add devices and link to Hub

Now, remove the plastic battery tab on each of your Airthings devices. To add the devices to your account, use the  sign in the App. Follow prompts to update your devices, if needed. Once the device is added accept invite to link. Linking can also be done using the  icon on the app device overview.

Depending on the firmware version of your Wave devices, the devices might need to go through a firmware update as part of the Hub configuration.

STEP 7

Congratulations!

After linking of a Wave family device is complete, the device will start searching for a Hub and connect to any of your Hubs.

This process typically takes between 15 minutes to 1 hour for full connectivity to the Hub.

Once your devices are connected to the Hub, the device overview screen in your app will show a signal strength indicator next to each device, instead of the Bluetooth icon. This shows that your device is connected to the Hub and as long as there is one bar, the connection is working.

Daily Use

Placement

Wave: Radon comes from the ground, so place the Wave device in the lowest commonly-used level of your home. Set it on a shelf or mount to the wall. We recommend keeping it at around breathing height and in sight.

Wave Mini: We recommend using the Wave Mini where you spend your time—a bedroom, the kitchen or living room. Use the stand, or mount to the wall.

Wave function

Wave in front of your device for a quick visual indication of your radon or indoor air quality levels. Green means good, yellow means warning, and red means danger.

Airthings Dashboard

For more detailed graphs and customizable dashboard, visit the Airthings Dashboard at dashboard.airthings.com.

Integrations

The Hub brings your Airthings products online, wirelessly. Live data allows for full integration into your smart home: set alerts, receive air quality measurements, give voice commands, connect to a smart plug or smart product to control your thermostat, air purifier, or humidifier—the options are endless.

Wave Mini: IFTTT, Google Assistant

Wave: IFTTT, Google Assistant, Amazon Alexa

Troubleshooting

Problem	Resolution
I can't find my Hub when adding it	Bluetooth must be enabled on your smartphone. For Android, GPS location must be enabled for Bluetooth low energy to function properly.
	You are not close enough to the Hub or there is wireless interference. Keep your phone less than 1m / 3 ft away from the Hub and search for Hub again.
	The Hub is already registered to another account. Therefore, it does not advertise its existence. Disconnect power and Ethernet cables from Hub, then connect only power cable and search for Hub again. When Hub is added, connect Ethernet cable again.
	Exit the "add device" screen and re-enter to try again.
I don't see my Wave device when linking it to a Hub	Bluetooth must be enabled on your smartphone. For Android, GPS location must be enabled for Bluetooth low energy to function properly.
	You are not close enough to the Wave device or there is wireless interference. Keep your phone less than 1m / 3ft away from the Wave device and search for device again.
	If the device was already connected to a Hub, Bluetooth will not turn back on again.
	Exit the "Link device" screen and re-enter to retry.
I don't want my Wave device to be connected to a Hub any more	Go to the Device Settings page of the Wave device and select Unlink . Follow the instructions in app.

<p>I don't see data coming from the Wave devices through the Hub</p>	<p>Make sure the linking process completed successfully in the app.</p>
	<p>Verify that power and cloud light indicators on the Hub are green for power and internet connectivity.</p> <p>If the Smartlink indicator is green, it means 1 or more Wave devices are already connected and you should wait.</p>
	<p>The Wave device might be out of range.</p> <p>Move the device close to the Hub for an hour and check if the App device overview indicates a Hub connection by showing a signal strength bar, then move the Wave back to its place and verify signal strength in the app.</p> <p>If the connection stops again, you might need to move the Hub to a different place.</p>
<p>I set my Hub to the wrong region. What should I do?</p>	<p>Please contact customer support to have it manually reset. After a region reset, the Wave devices must be unlinked and the Hub unpaired from your account before starting the setup over again.</p>

Common Questions

What is the range of the Hub?

The Hub will typically have full coverage from anywhere in a home. Tests show that in most cases the range should be more than enough for a large family home. Range may vary depending on wall and floor materials, wireless interference, placement, and other factors.

How many devices can be connected to a Hub?

The Hub can support up to 10 devices being connected to it.

What devices can be connected to an Airthings Hub?

The Wave Plus, Wave Mini and Wave 2nd gen devices can be connected to an Airthings Hub. Wave 1st gen (serial number 2900x) cannot be connected to a Hub.

Can I use a Wave device both with a Hub and with Bluetooth simultaneously?

A: This is currently not supported. Once a Wave device connects to a Hub, Bluetooth will be disabled until the device is unlinked through device settings.

Can I retrieve data locally from the Hub?

This is unfortunately not possible. The data is encrypted in transit to the Airthings cloud and is retrieved again through the Airthings Wave app or web dashboard at <https://dashboard.airthings.com>.

How often does the Wave devices send in data through the Hub?

The Wave devices send in data every 5 minutes. Radon data (24 hour rolling average) is sent in every hour.

Regulatory Information

Regulatory information Canada

Changes or modifications not expressly approved by the party responsible for compliance could void the user's authority to operate the equipment.

This device complies with Innovation, Science and Economic Development Canada's licence-exempt RSS(s). Operation is subject to the following two conditions: (1) This device may not cause interference; and (2) This device must accept any interference, including interference that may cause undesired operation of the device.

RF exposure safety

This product is a radio transmitter and receiver. It is designed not to exceed the emission limits for exposure to radio frequency (RF) energy set by the ISED. The antenna must be installed and operated with a minimum distance of 20 cm between the radiator and your body. This transmitter must not be co-located or operating in conjunction with any other antenna or transmitter.

CAN ICES-3 (B)/NMB-3(B)

This Class B digital apparatus complies with Canadian ICES-003

Regulatory information USA

Changes or modifications not expressly approved by the party responsible for compliance could void the user's authority to operate the equipment.

This device complies with part 15 of the FCC Rules. Operation is subject to the following two conditions: (1) This device may not cause harmful interference, and (2) this device must accept any interference received, including interference that may cause undesired operation.

Class B device notice

NOTE: This equipment has been tested and found to comply with the limits for a Class B digital device, pursuant to part 15 of the FCC Rules. These limits are designed to provide reasonable protection against harmful interference in a residential installation. This equipment generates, uses and can radiate radio frequency energy and, if not installed and used in accordance with the instructions, may cause harmful interference to radio communications. However, there is no guarantee that interference will not occur in a particular installation. If this equipment does cause harmful interference to radio or television reception, which can be determined by turning the equipment off and on, the user is encouraged to try to correct the interference by one or more of the following measures:

- Reorient or relocate the receiving antenna.
- Increase the separation between the equipment and receiver.
- Connect the equipment into an outlet on a circuit different from that to which the receiver is connected.
- Consult the dealer or an experienced radio/TV technician for help.

RF exposure safety

This product is a radio transmitter and receiver. It is designed not to exceed the emission limits for exposure to radio frequency (RF) energy set by the Federal Communications Commission. The antenna must be installed and operated with a minimum distance of 20 cm between the radiator and your body.

This transmitter must not be co-located or operating in conjunction with any other antenna or transmitter.

Safety and maintenance

This product is intended for indoor use only. Avoid direct exposure to sunlight for long periods. Avoid exposure to direct heat sources. For correct usage, make sure the detector is operating in the specified temperature range (see technical specifications for individual products). Exposure to high humidity might permanently alter the detector sensitivity or damage it. Do not disassemble. If the detector does not work as specified or you are in doubt, contact your local dealer or visit us at Airthings.com. Use a dry cloth to clean the detector. When replacing the batteries, pay attention to the polarity marks. Always snap the mounting bracket to the detector's rear side to protect the batteries, even when the detector is not permanently mounted. Disposal: electronic equipment.

Frequency Bands

Frequency bands and the maximum radio-frequency power transmitted in the frequency bands in which the Airthings instruments operate:

Hub (Model:2810) / Hub Cellular
(Model: 2820)
FCC ID: 2APPT-2820
IC: 23900-2820

Wave 2 (Model: 2950) / Wave Plus
(Model: 2930)
FCC ID: 2APPT-2930
IC: 23900-2930

Wave Mini (Model: 2920)
FCC ID: 2APPT-2920
IC: 23900-2920

Frequency Range (MHz):2402.0 - 2480.0 (Bluetooth)

Output power: <5 mW

Frequency Range (MHz) in Europe: 868 - 870 MHz (SmartLink)

Output power: <25 mW

Frequency Range (MHz) in North America: 902 - 928 MHz (SmartLink)

Output power: <25 mW

Hub 2820 GSM Frequency Range: GSM 900 MHz, GSM 1800 MHz, GSM 850 MHz, GSM 1900 MHz

LTE Cat M1 Frequency Range: LTE B1 2100 MHz, LTE B2 1900 MHz, LTE B3 1800 MHz, LTE B4 1700 MHz, LTE B5 850 MHz, LTE B8 900 MHz, LTE B12 700 MHz, LTE B13 700 MHz, LTE B18 850 MHz, LTE B19 850 MHz, LTE B20 800 MHz, LTE B26 850 MHz, LTE B28 700 MHz, LTE B39 1900 MHz

The Hub (Model 2810) and Hub Cellular (Model 2820) contain a power supply tested according to the following standards: UL60950, EN60950, BS60950, AS/NZS60950 and tested to comply with FCC standards for home or office use CAN ICES-3 (B)/NMB-3(B). The power supply is certified by TUV Rheinland US (TUV020687EA)

EU declaration of conformity

Hereby, Airthings AS, Wergelandsveien 7, 0167 Oslo, declares that this product is in compliance with Directive 2014/53/EU. The full text of the EU declaration of conformity is available at the following internet address: airthings.com/regulatory-information.

Limited liability

The instruments are tested and quality-assured by production. They meet the accuracy values set out in the specifications. It is recommended to keep the instruments constantly activated and the batteries in place until drained.

Airthings AS shall not be liable for damages related to failure or loss of data arising from incorrect operations and handling of the instruments.

Terms & conditions can be found on airthings.com/terms-use-privacy/

For additional questions go to support.airthings.com

The Bluetooth word mark and logos are registered trademarks owned by the Bluetooth SIG, Inc. and any use of such marks by Airthings is under license.

Copyright Airthings AS, 2020